

Illuminazioni a LED

TRACK SIL

Finitura:

Alluminio

Installazione:

Da cassetto

Con interruttore infrarad e controllo della temperatura integrato

Dimensioni:

L = mm. 600 W = 5,4 LED 3

L = mm. 900 W = 7,2 LED 4

L = mm. 1200 W = 9,0 LED 5

Accessori da ordinare a parte:

- Alimentatore led 230V a 6 vie 15W (ART. ALILED15)
- 30W (ART. ALILED)

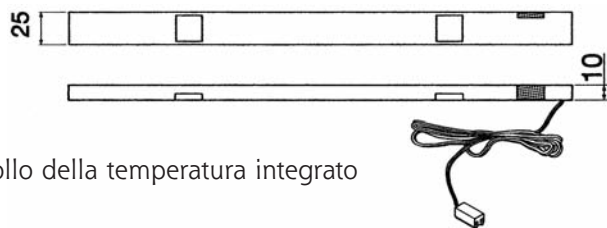

MANILA

Finitura:

Alluminio

Installazione:

Da incasso

Disponibile anche:

- con interruttore Touch integrato
- con interruttore Sensor

Dimensioni:

L = mm. 500 W = 2,4 LED 36

L = mm. 760 W = 4,1 LED 60

L = mm. 1000 W = 5,8 LED 84

Accessori da ordinare a parte:

- Alimentatore led 230V a 6 vie 15W (ART. ALILED15)
- 30W (ART. ALILED)

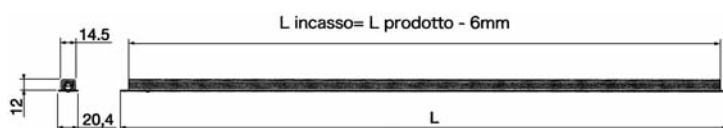

BALI

Finitura:

Alluminio

Installazione:

Esterno

Disponibile anche:

- con interruttore Touch integrato

Dimensioni:

L = mm. 450 W = 1,65 LED 24

L = mm. 600 W = 2,40 LED 36

L = mm. 900 W = 4,95 LED 72

L = mm. 1200 W = 6,60 LED 96

Accessori da ordinare a parte:

- Alimentatore led 230V a 6 vie 15W (ART. ALILED15)
- 30W (ART. ALILED)

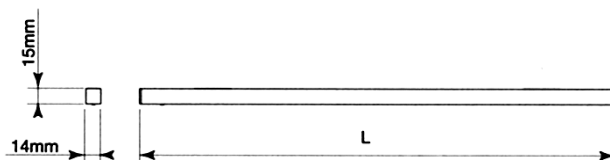

VENICE

Finitura:

Alluminio

Installazione:

Incasso verticale/orizzontale

Dimensioni:

L = mm. 500 W = 2,4 LED 36

L = mm. 760 W = 4,1 LED 60

L = mm. 1000 W = 5,65 LED 84

Accessori da ordinare a parte:

- Alimentatore led 230V a 6 vie 15W (ART. ALILED15)
30W (ART. ALILED)
- Alimentatore led 12V a 6 vie 30W con sensore (ART. ALILED5)

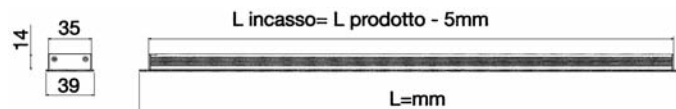

FARETTO SUNNY

Finitura:

Acciaio spazzolato

Installazione:

Incasso

Dimensioni:

SUNNY TT Ø63 LED 18

3200 °K Luce calda W = 1,25

5100 °K Luce fredda W = 1,25

SUNNY QQ mm 74x74 LED 16

3200 °K Luce calda W = 1,25

5100 °K Luce fredda W = 1,25

Accessori da ordinare a parte:

- Alimentatore led 230V a 6 vie 15W (ART. ALILED15)
30W (ART. ALILED)
- Alimentatore led 12V a 6 vie 30W con sensore
(ART. ALILED5)

ART. SUNNY TT

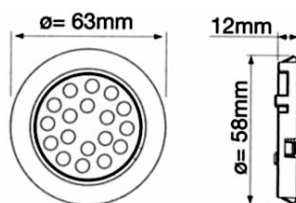

ART. SUNNY QQ

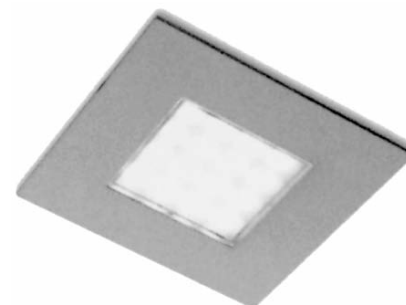
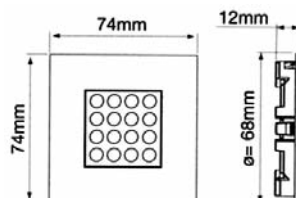

FARETTO POWER

Finitura:

Alluminio

Installazione:

Incasso

Dimensioni:

POWER K1 Ø30 LED 1 W = 1,20

POWER K3 Ø47 LED 1 W = 1,20

Accessori da ordinare a parte:

- Alimentatore led 230V a 6 vie ART. ALIPOWER

ART. POWER K1

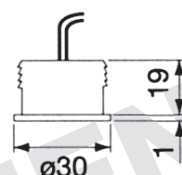

ART. POWER K3

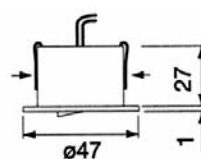

IN ESAURIMENTO

STRIP LED HE

Finitura:

Alluminio e lente
Luce fredda e luce calda

Installazione:

Incasso (completa di clips di fissaggio)
Sistema modulare a connessione rapida

Dimensioni:

L = mm. 125 W = 0,8 LED 12
L = mm. 250 W = 1,65 LED 24

Accessori da ordinare a parte:

- Alimentatore led 230V a 6 vie 15W (ART. ALILED15)
30W (ART. ALILED)
- Interruttore Touch per led (ART. TOUCH)
- Cavo di connessione tra barre led:
 - L. mm. 30 ART. STRIPCON30
 - L. mm. 300 ART. STRIPCON300
- Prolunga
 - L. mm. 1000 ART. STRIPPROL1
 - L. mm. 2000 ART. STRIPPROL2

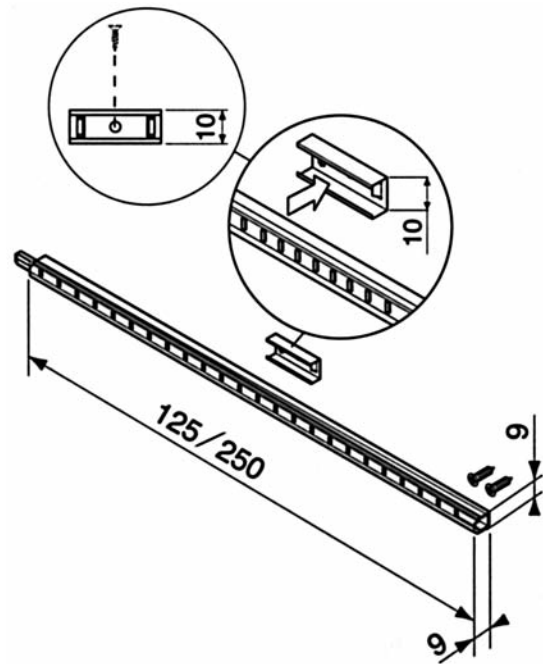
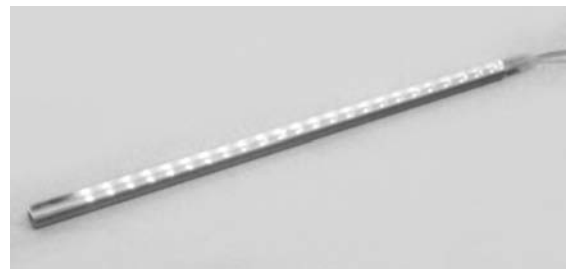

FLEX LED

Finitura:

Profilo in gomma trasparente e isolante

Installazione:

Supporto adesivo

Dimensioni:

L = mm. 300 W = 0,8 LED 12
L = mm. 2000 W = 4,9 LED 72

Accessori da ordinare a parte:

- Alimentatore led 240V a 6 vie 15W (ART. ALIFLEX15)
30W (ART. ALIFLEX)
- Cavo di connessione tra led:
 - L. mm. 40 ART. FLEXLEDCON04
 - L. mm. 100 ART. FLEXLEDCON10
 - L. mm. 500 ART. FLEXLEDCON50
- Prolunga
 - L. mm. 1000 ART. FLEXLEDPROL1
 - L. mm. 2000 ART. FLEXLEDPROL2
 - L. mm. 4000 ART. FLEXLEDPROL4
- Cavo di connessione intermedio a T
 - L. mm. 160 ART. FLEXLEDT

